

2,4-D Plate, Detailed ELISA Procedure

1. Addition of Standards, Samples

Add 50 μ L of calibrators or sample into the wells of the test strips according to the working scheme given. Be sure to use a clean pipet tip for each.

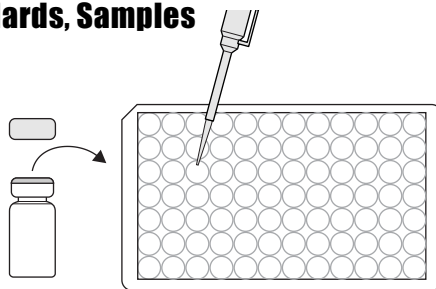

2. Addition of Enzyme Conjugate

Add 50 μ L of the enzyme conjugate to the individual wells successively using a multi-channel pipette or a stepping pipette.

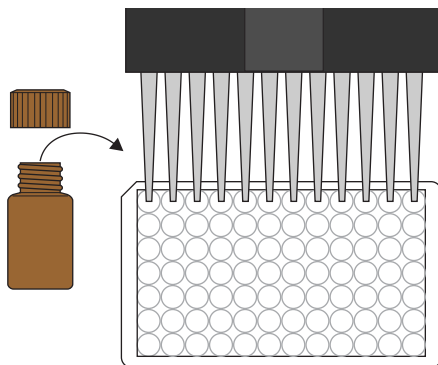

3. Addition of Antibody Solution

Add 50 μ L of the antibody solution to the individual wells successively using a multi-channel pipette. Cover the wells with parafilm or tape and mix the contents by moving the strip holder in a rapid circular motion on the benchtop. Be careful not to spill contents. Incubate the strips for 60 min. at room temperature.

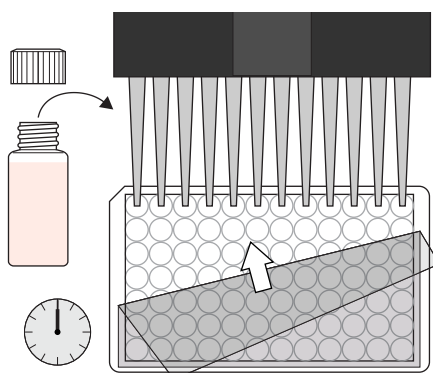

4. Washing of Plates

After incubation, remove the covering and vigorously shake the contents of the wells into a sink. Wash the strips three times with a multi-channel pipette or wash bottle using the diluted 1X washing buffer solution. Please use at least a volume of 250 μ L of washing buffer for each well and each washing step. Remaining buffer in the wells should be removed by patting the plate dry on a stack of paper towels.

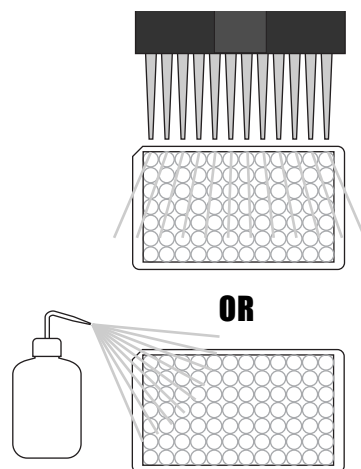

5. Addition of Substrate/Color Solution

Add 150 μ L of substrate/color solution to the individual wells successively using a multi-channel pipette or a stepping pipette. Cover the wells with parafilm or tape and mix the contents by moving the strip holder in a rapid circular motion on the benchtop. Be careful not to spill contents. Incubate the strips for 20 min. at room temperature.

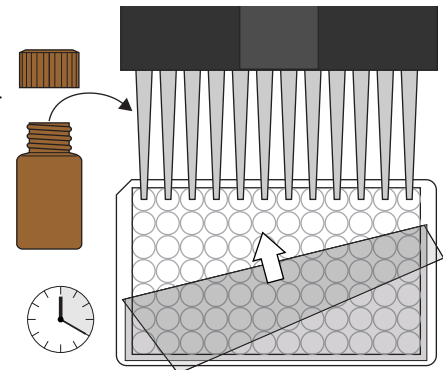

6. Addition of Stopping Solution

Add 100 μ L of stop solution to the wells in the same sequence as for the substrate solution using a multi-channel pipette or a stepping pipette.

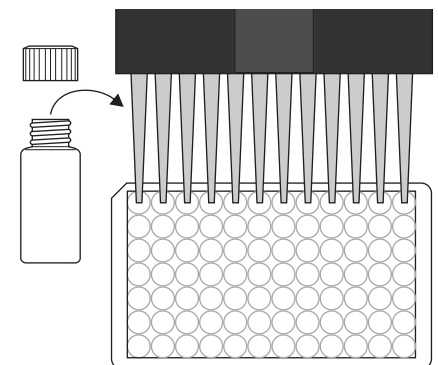

7. Measurement of Color

Read the absorbance at 450 nm using a microplate ELISA reader. Calculate results.

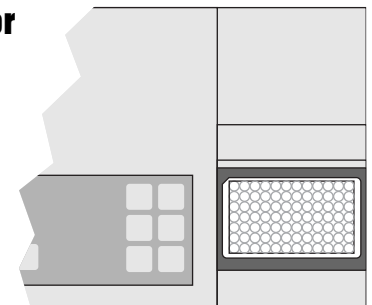

For Ordering or Technical Assistance Contact:
ABRAXIS, LLC
54 Steamwhistle Drive, Warminster, PA 18974
Phone: 215-357-3911 Fax: 215-357-5232
www.abraxiskits.com

2,4-D Plate Kit Part # 54003A

2,4-D Plate, Concise ELISA Procedure

1. Addition of Standards, Samples

Add 50 μ L of calibrators or diluted sample extracts.

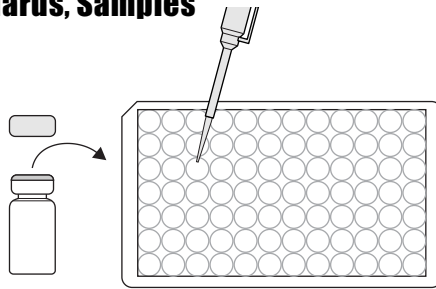

2. Addition of Enzyme Conjugate

Add 50 μ L of enzyme conjugate.

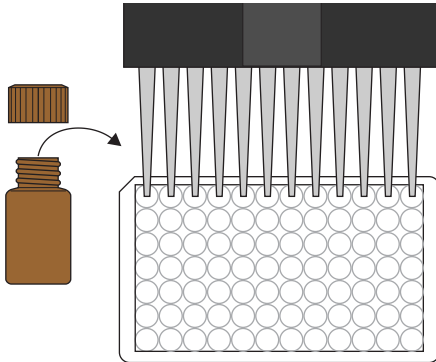

3. Addition of Antibody Solution

Add 50 μ L of the antibody solution. Cover and mix for 30 seconds by rotating on benchtop. Incubate for 60 minutes at room temperature.

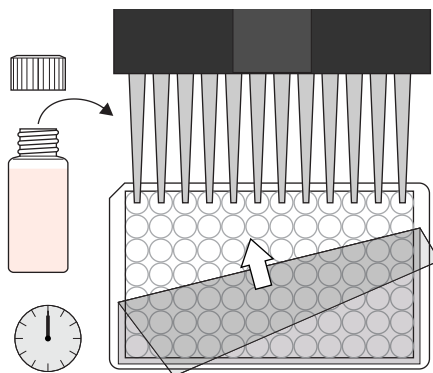

4. Washing of Plates

Wash the plates three times with 250 μ L of diluted 1X washing buffer.

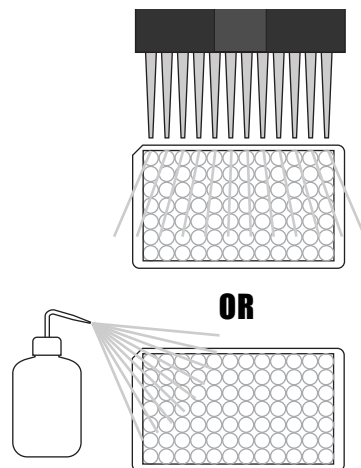

5. Addition of Substrate/Color Solution

Add 150 μ L of substrate/color solution. Incubate 20 minutes at room temperature and away from direct sunlight.

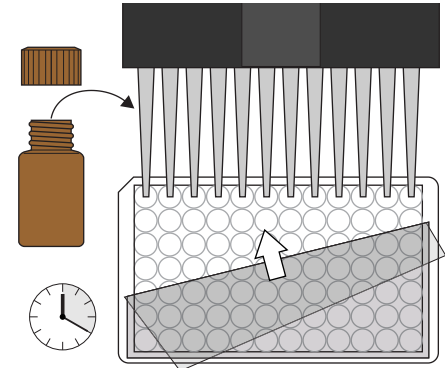

6. Addition of Stopping Solution

Add 100 μ L of stop solution.

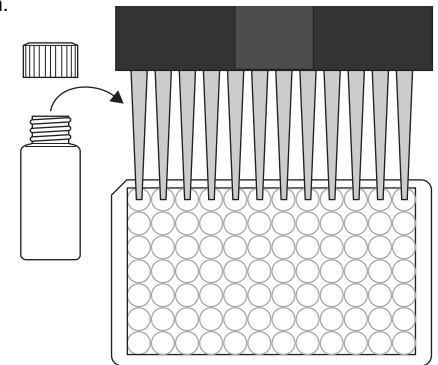

7. Measurement of Color

Measure color at 450 nm. Calculate results.

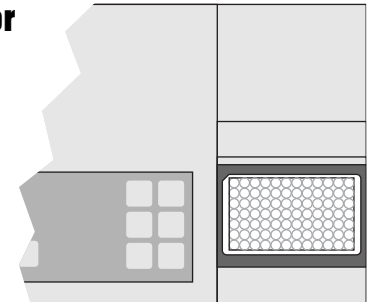

For Ordering or Technical Assistance Contact:
ABRAXIS, LLC
54 Steamwhistle Drive, Warminster, PA 18974
Phone: 215-357-3911 Fax: 215-357-5232
www.abraxiskits.com

2,4-D Plate Kit Part # 54003A